

MONTAGEANLEITUNG

PF MOTO & PF MINI
FÜR EINSPURIGE FAHRZEUGE & ROLLSTÜHLE & GARTENGERÄTE



GRUPPE

QUALITÄT FÜR HÖCHSTE ANSPRÜCHE



DEUTSCHER
QUALITÄTSSTANDARD



KOSTENLOSE LIEFERUNG
DEUTSCHLANDWEIT!

*AUSGENOMMEN INSELN



Geprüftes
Onlineportal
Informationsservice

tuev-saar.de/SC43356

BAUDISCOUNT
ZERTIFIZIERTES
ONLINEPORTAL

Die Fachgerechte Montage sollte durch einen Zertifizierten Montagebetrieb erfolgen.
 Sollten Sie die Montage in Eigenverantwortung durchführen, halten Sie sich an die in der Anleitung und in dem Montage Video beschriebenen und gezeigten Arbeitsschritte.
 Voraussetzung für die fachgerechte Montage ist ein nach DIN erstelltes frostsicheres Fundament.

YouTube



Die Montage der einzelnen Wandelemente muss nach Herstellervorgabe erfolgen.

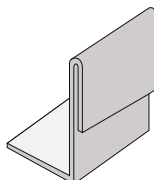
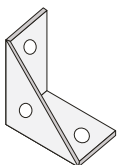
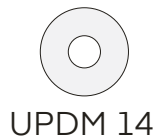
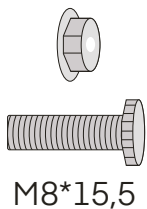
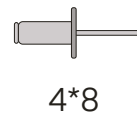
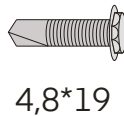
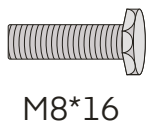
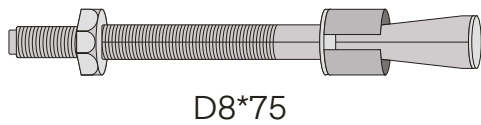
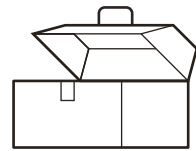
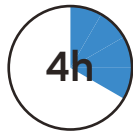
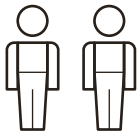
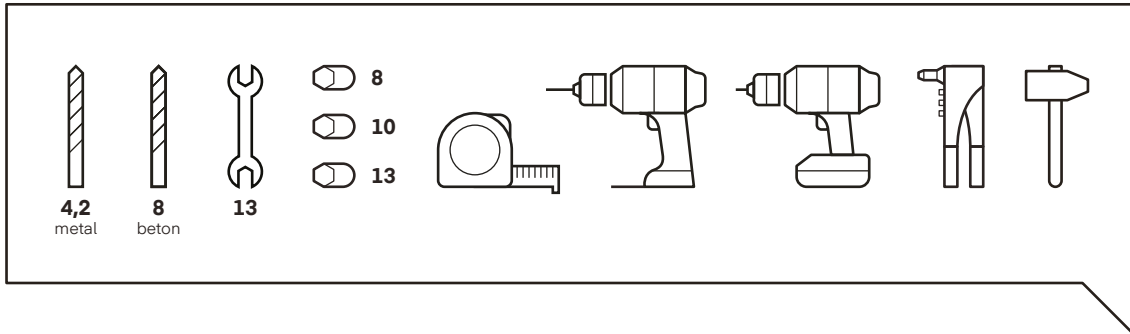

T10 Dachblech

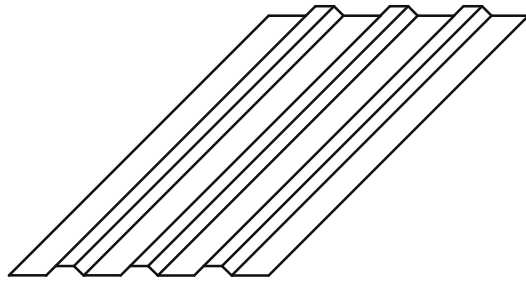

BDL **BDF** **BDR** Dachblende

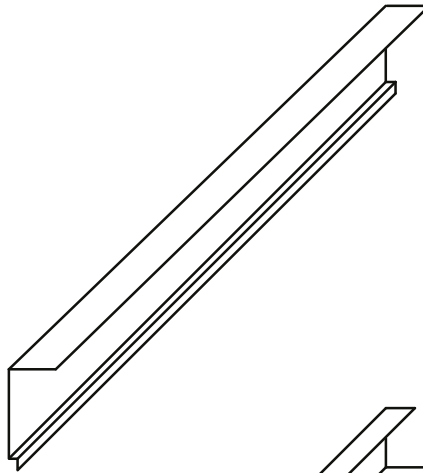

KPF Front Dachwinkel

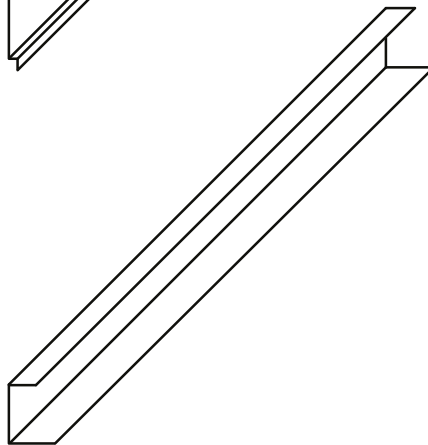

BN Eckblende



Z Dachbalken (C-Träger)

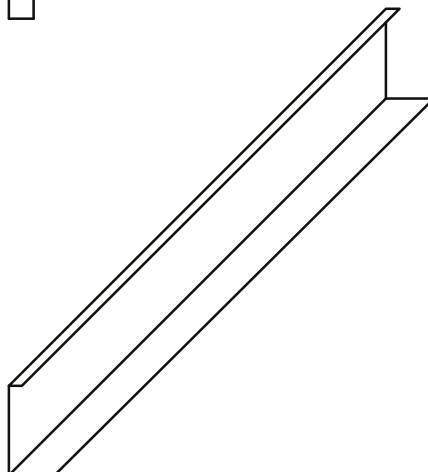

1

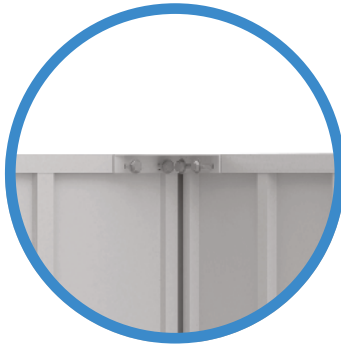
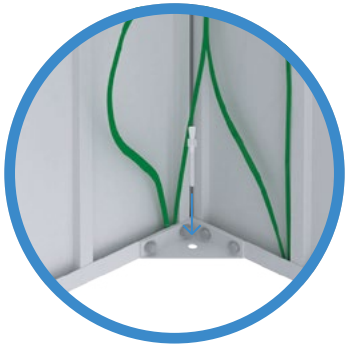
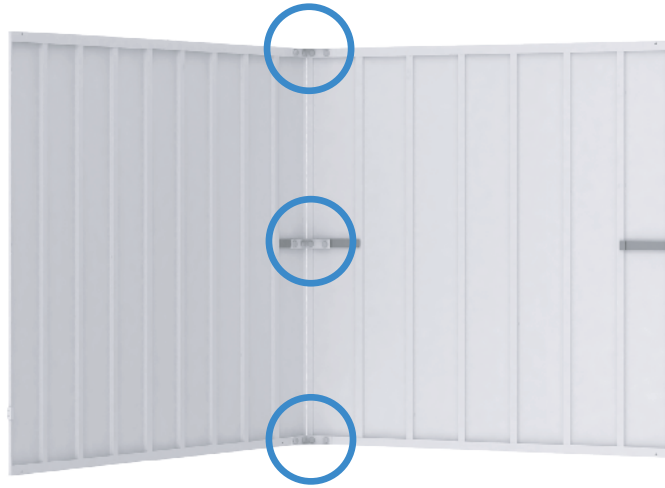

M8*16 + Schraubenmutter

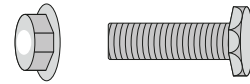

D8*75

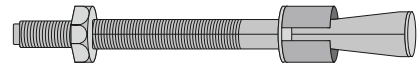

2

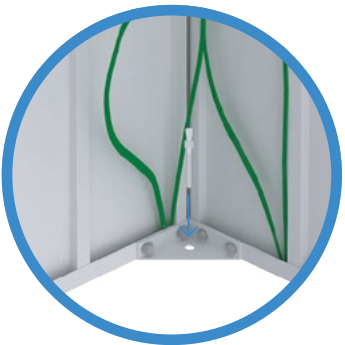
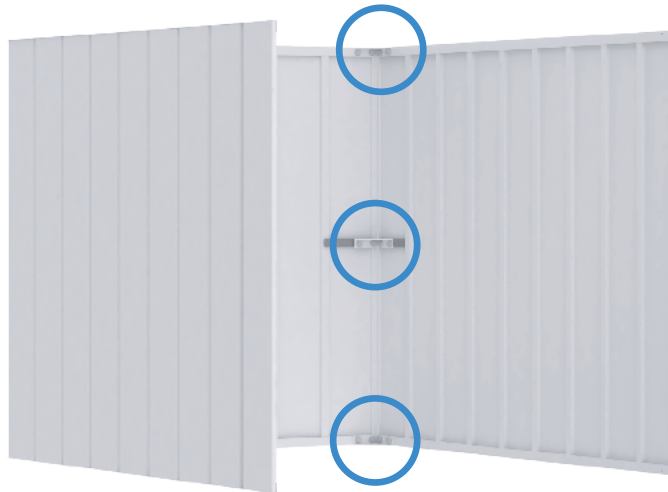

M8*16 + Schraubenmutter

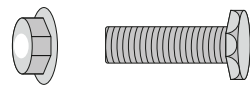

D8*75

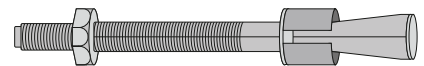

3

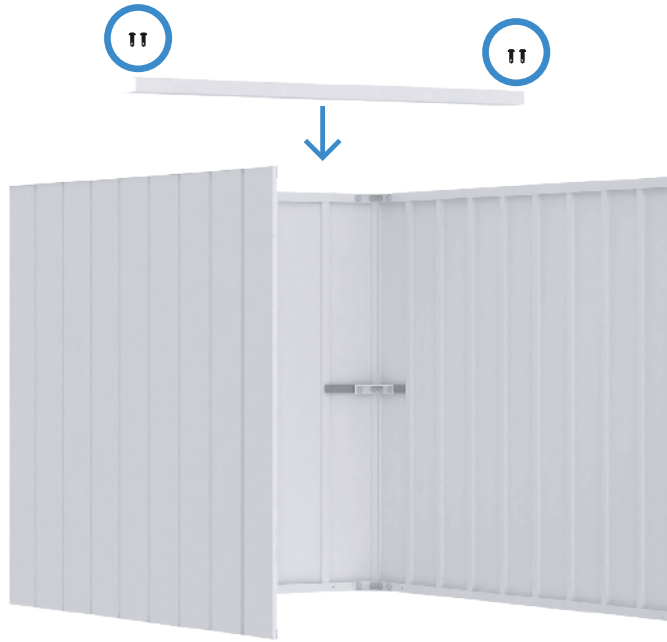

4,8*19

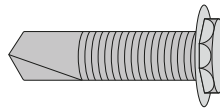

4

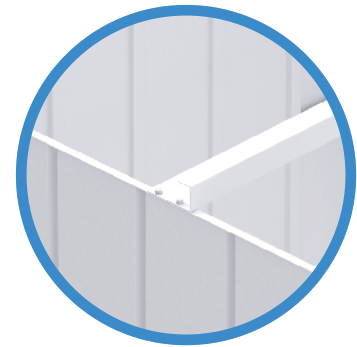
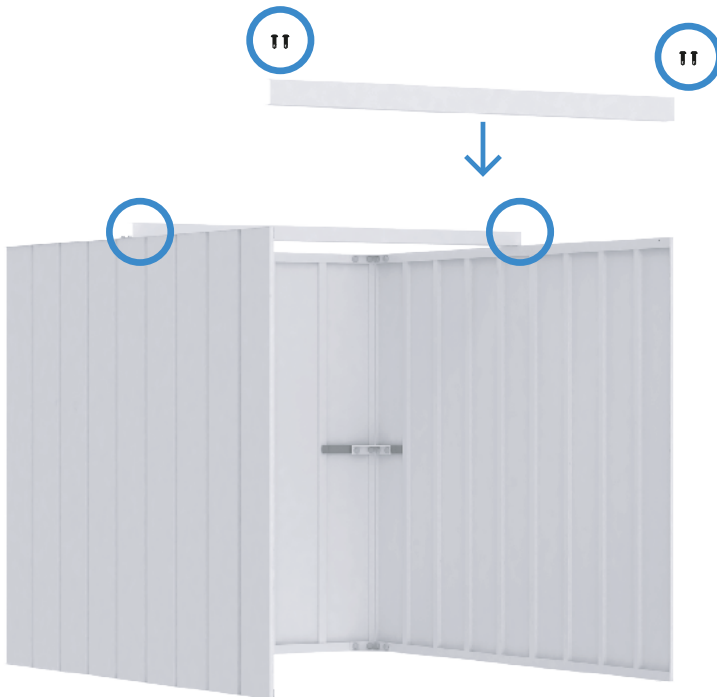

4,8*19

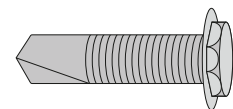

5



6

Zuerst die Diagonalen ohne Tor überprüfen.

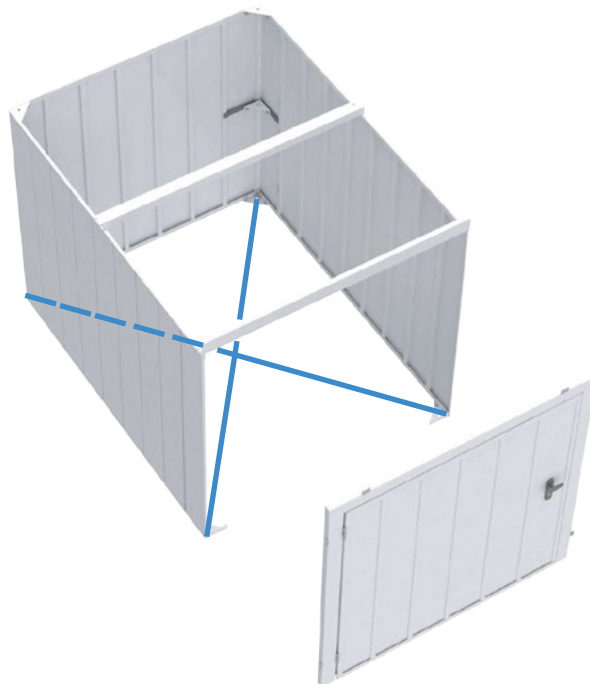

7

Im nachhinein die Diagonalen mit Tor überprüfen.



8

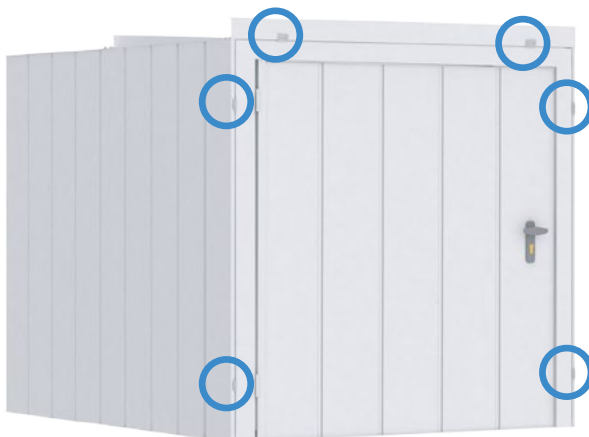

4,8*19

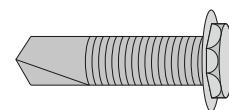

9



4,8*19

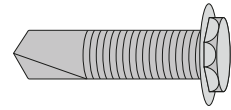

10

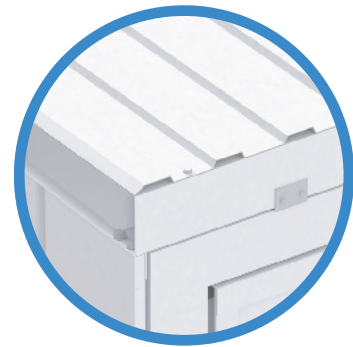

4,8*19

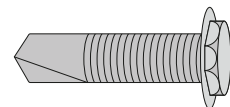

11

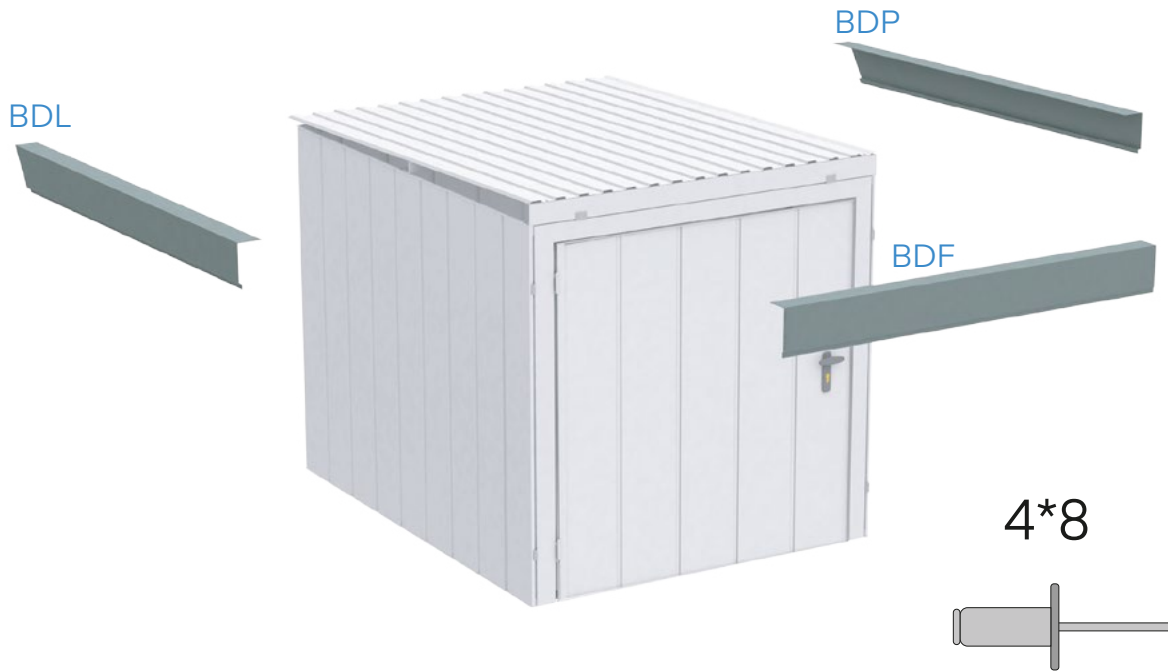

12



13



4*8

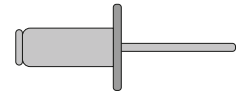

KPF

14

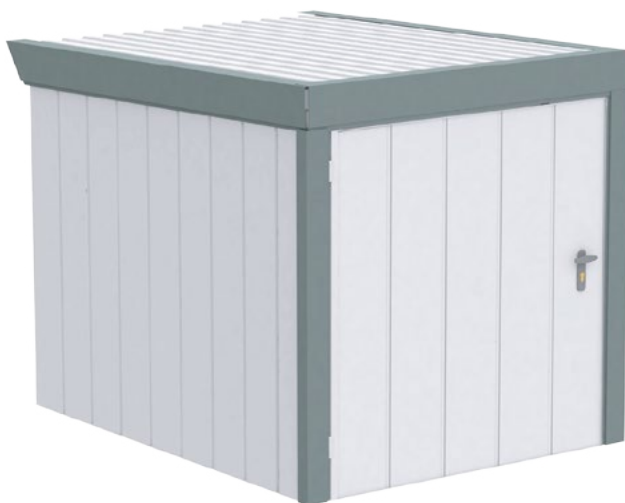

4*8

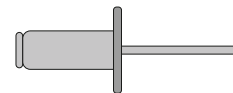

15



4*8

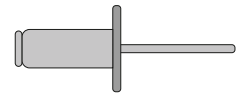

16

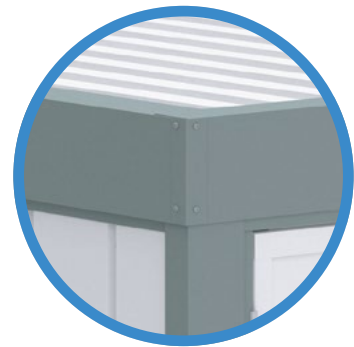
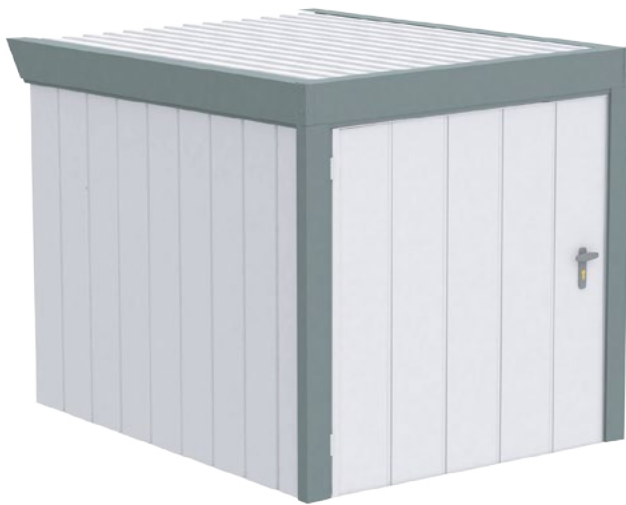

4*8

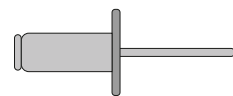

17



D8*75

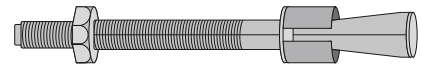

18





GRUPPE

QUALITÄT FÜR HÖCHSTE ANSPRÜCHE

PF GRUPPE FACHHÄNDLER:

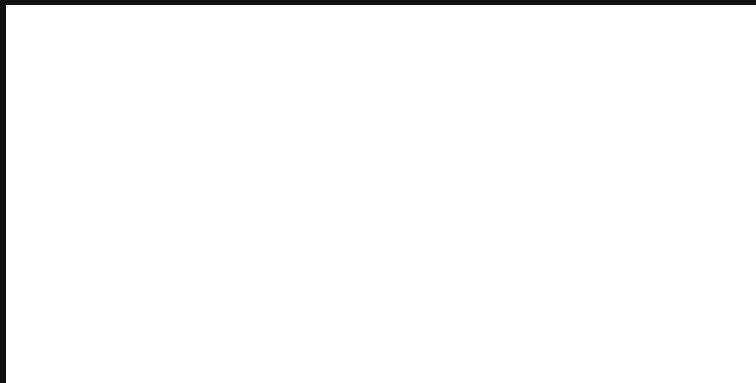

EUROPAWEITER VERTRIEB DURCH DIE



Baustoff-Euro-Trade
GmbH